

UFO HIGHBAY

HW-UFO-01-200W-PS-CCT



Power Selectable: 3-IN-ONE, 110W, 150W, 200W

3 CCT Selectable: 3000K, 4000K, 6000K

3 beam angles Selectable: 60°, 90°, 110° with zommable optic design by simple rotation Tool free Installation and Maintenance

The ripple-like lens cover diffuses the dazzling light generated by individual LEDs.

FEATURES

- Built in high luminous efficiency LED Chip and Driver.
- Fast connection
- IP65
- Adjustable Beam Angle

APPLICATION

- Factory Workshop
- Warehouse
- Parking Lot
- Conference Room
- Storage Room
- Sports Field

Indoor



CE IP65



Multi Beam Angle Switchable



Multi Wattage Switchable



Multi Color Temperature (CCT)

OPTICAL DATA		PHYSICAL DATA		ELECTRICAL DATA	
Color Temperature (CCT)	3000K, 4000K, 6000K	Finish	Black	Input Power	110W, 150W, 200W
Luminous Flux	19500, 26400, 34600 Lm	Protection Level - IP	IP 65	Power Switchable	YES
Beam Angle	60°, 90°, 110° Adjustable	Dimensions	300x167mm	Operating Voltage	100-277V
Type of Distribution	Direct Symmetrical	Type of Installation	Hanging, Ceiling, Wall	Frequency	50-60 Hz
Optical Material	Diffuser PC	Body Frame	Aluminium	Power Factor	>0.9
Life Span	50 000 Hrs	Weight	2.0 kg	CRI	80
		Operation Temperature	-30°C to +45°C	Dimmable	NO

DIMENSIONS

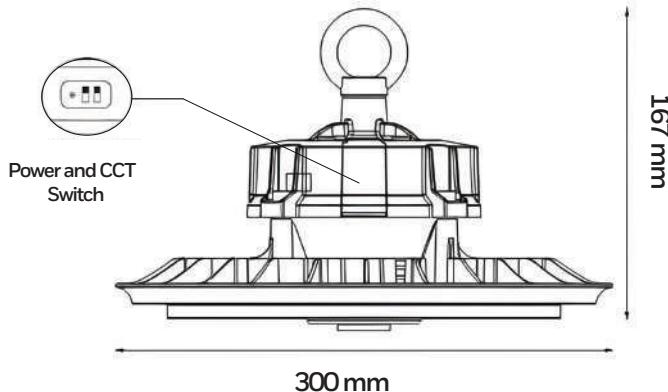

ADDITIONAL INFORMATION

New heat dissipation system to ensure long lifetime



UFO HIGHBAY

HW-UFO-01-200W-PS-CCT

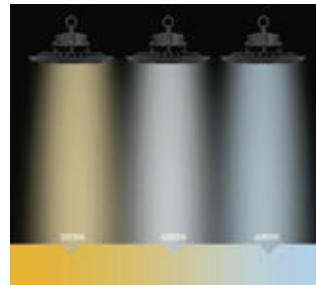
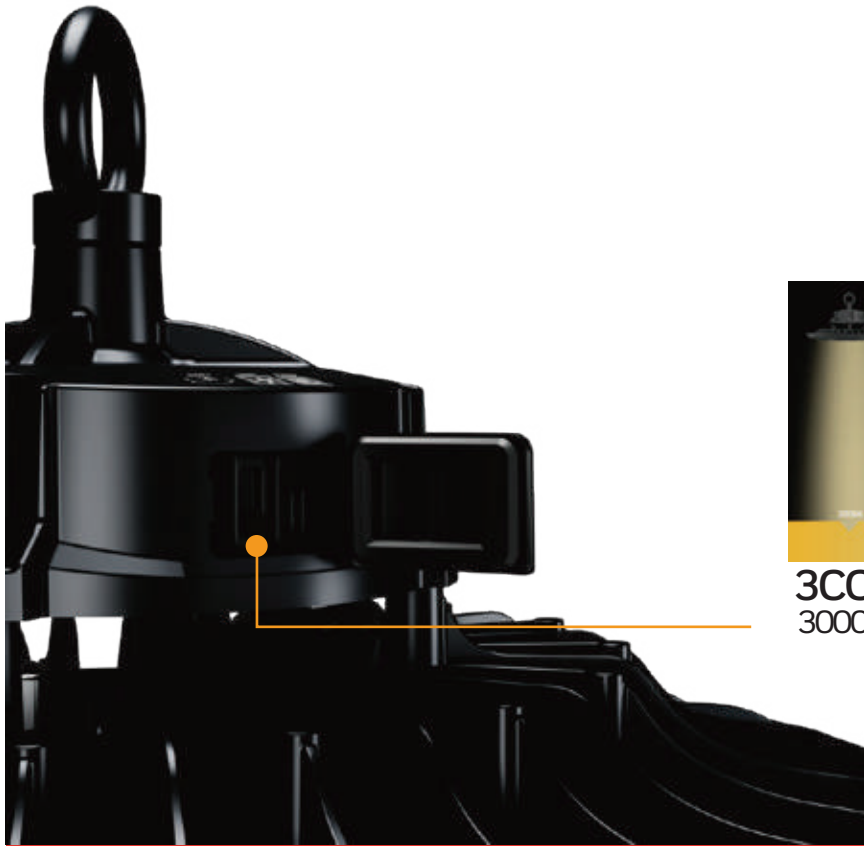

3 CCT Selectable
3000K, 4000K, 6000K

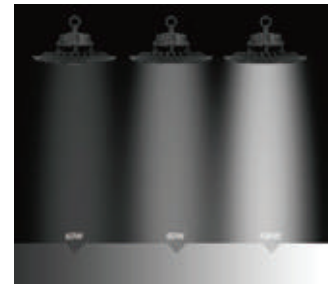

3 Power-in-1
110W/150W/200W
selectable

Rotate the lens to change the beam Angle

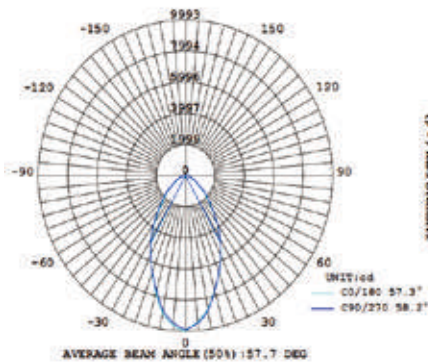

60deg

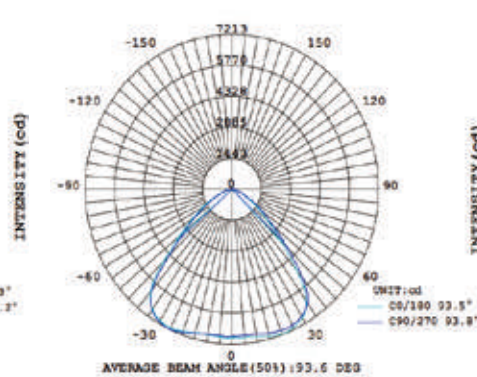

90deg

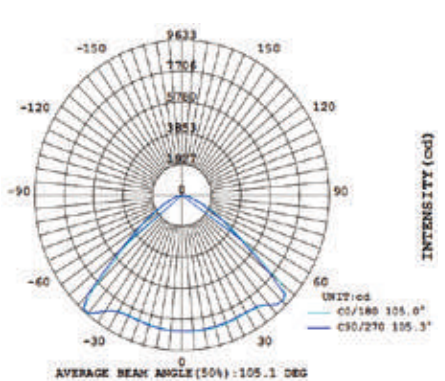

110deg